

**- GUIDE LINEARI -**

*- Precision Linear Guideway -*

**- DRAI MILANO SRL -**

**CSK**

Linear motion technology

**Via Curiel, 16**

**20026 Novate Milanese (MI)**

**Tel.: 02/87066850**

**Fax.: 02/87066869**

**Email: [draimilano@libero.it](mailto:draimilano@libero.it)**

**Sito: [www.draimilano.it](http://www.draimilano.it)**



### 4. Carriage Type - Tipo di pattino

#### Contour - Versione

#### Length - Lunghezza

#### Spec. code - Codice

Flange type -  
*Versione flangiata*

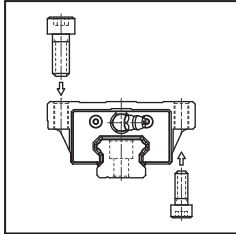

Heavy load -  
*Carico Pesante*

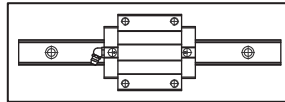

LMG ... C

Ultra heavy load - *Carico ultra pesante*

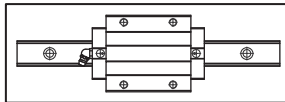

LMG ... LC

Square high type -  
*Versione quadrata  
alto tipo*

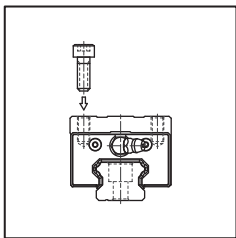

Heavy load -  
*Carico Pesante*

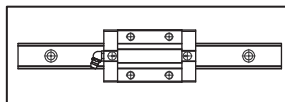

LMG ... H

Ultra heavy load - *Carico ultra pesante*

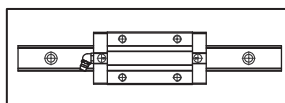

LMG ... LH

Square medium type -  
*Versione quadrata  
tipo medio*

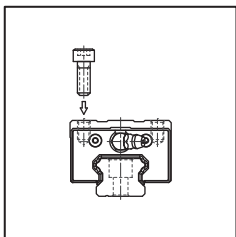

Heavy load -  
*Carico Pesante*

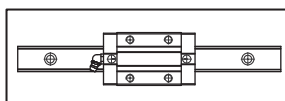

LMG ... V

Ultra heavy load - *Carico ultra pesante*

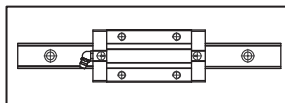

LMG ... LV

Square compact type -  
*Versione quadrata  
tipo compatta*

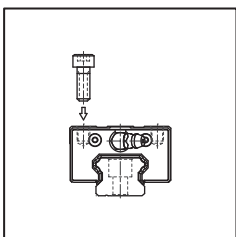

Medium load - *Carico medio*

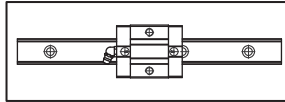

LMG ... ST

Heavy load - *Carico pesante*

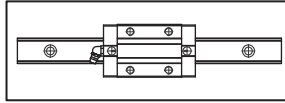

LMG ... T

Ultra heavy load - *Carico ultra pesante*

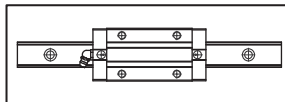

LMG ... LT

## 13. Dimensions of LMG...V / LV - Dimensioni

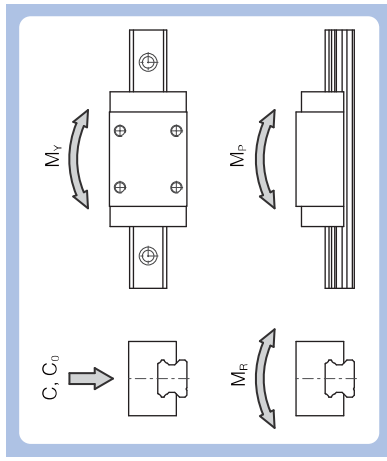
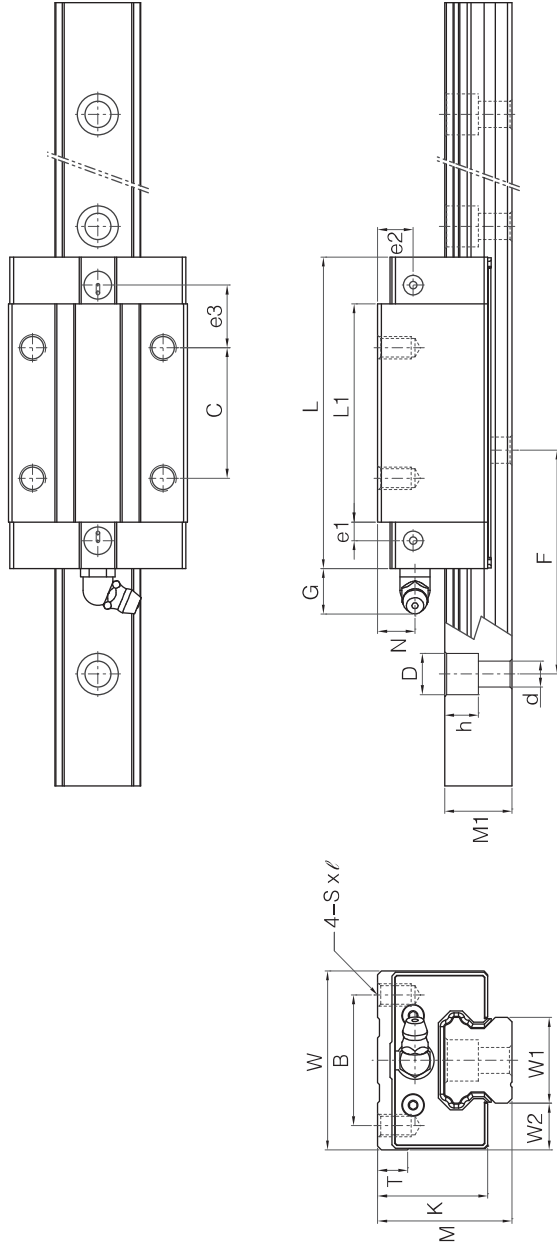

Model No.	External dimension		Carriage dimension							Rail dimension			Basic load rating		Static moment rating				Weight										
	Height	Width	M	W	L	B	C	Sx/l	L1	T	K	N	e1	e2	e3	G	Grease nipple	Width	Height	Pitch	Dxhxd	Dynamic	Static	Mp (KN-m)	My (KN-m)	MR (KN-m)	Carriage	Rail	
	M	W	L	B	C	Sx/l	L1	T	K	N	e1	e2	e3	G	Grease nipple	Width	Height	Pitch	Dxhxd	C	C0	Single Carriage	Double Carriages	Single Carriage	Double Carriages	Single Carriage	Double Carriages	Kg	kg/m
<b>LMG25 V</b>	36	48	83.6	35	35	M6x9	58.6	8	29.5	10	5	9.5	16.8	12	M6x0.75	23	12.5	18	60	11x9x7	27.9	42.5	0.44	2.47	0.44	2.47	0.51	0.47	2.67
<b>LMG25 LV</b>	36	48	102.6	35	50	M6x9	77.6	8	29.5	10	5	9.5	18.8	12	M6x0.75	23	12.5	18	60	11x9x7	34.2	56.6	0.76	3.99	0.76	3.99	0.67	0.61	2.67

Unit : mm

Note : "Double carriages" in static moment rating means two carriages are closely contacting with each other.

# *drai milano srl*



Via Curiel, 16

20026 Novate Milanese (MI)

Tel: 02/87066850

Fax.: 02/87066869

Email: [draimilano@libero.it](mailto:draimilano@libero.it)