

- SERIE MRDB -
Riduttori Vite senza Fine
Worm Gearboxes

ELLE.GI SRL

*Organi di
Trasmissione*



12.5 DIMENSIONI ACCESSORI / ACCESSORIES OUTLINE DIMENSION SHEET

12.5.1 Alberi in uscita / Output Shafts

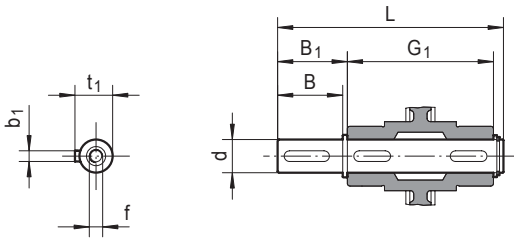

SS

	d _{h6}	B	B1	t1	L	f	G1	b1
MRDB 30	14	30	32.5	16	120	M5x13	55	5
MRDB 44	18	40	42.7	20.5	149.4	M6x16	64	6
MRDB 49	25	60	63.2	28	208.4	M8x19	82	8

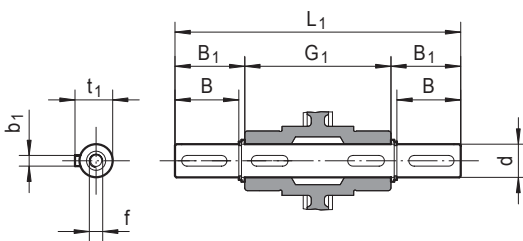

DS

	d _{h6}	B	B1	t1	L1	f	G1	b1
MRDB 30	14	30	32.5	16	120	M5x13	55	5
MRDB 44	18	40	42.7	20.5	149.4	M6x16	64	6
MRDB 49	25	60	63.2	28	208.4	M8x19	82	8

* Solo su richiesta
* Only on request

12.5.2 Braccio di reazione / Torque Arm

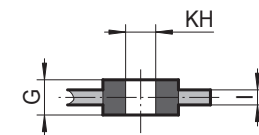
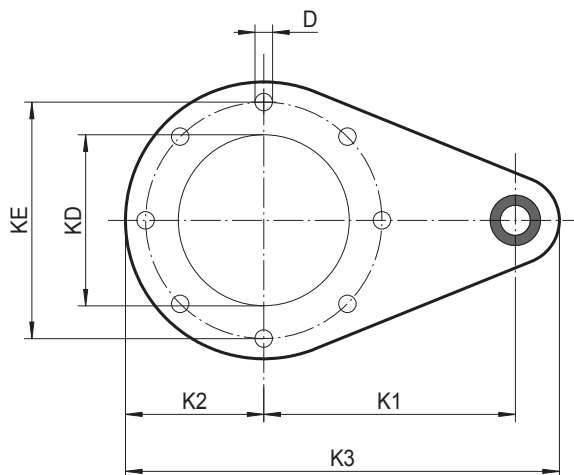

without vibration-dampening bushing

	K1	K2	K3	KD	KE	D	G	KH	I
MRDB 30	100	40	157.5	50	65	7	14	8	4
MRDB 44	100	40	157.5	50	65	7	14	8	4
MRDB 49	100	55	172.5	68	94	7	14	8	4

12.6 **MRDB..** SCHEMA POSIZIONI DI MONTAGGIO / **INSTALLATION POSITIONS DIAGRAM**

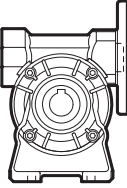
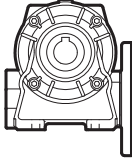
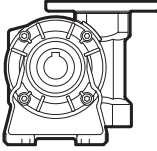
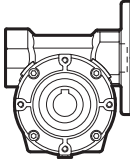
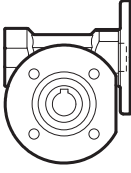
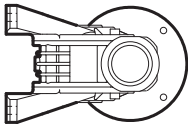
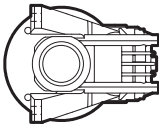
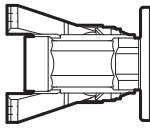
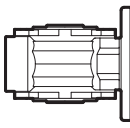
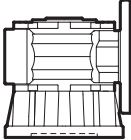
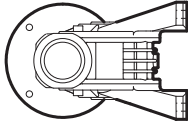
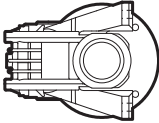
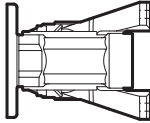
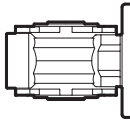
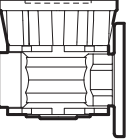
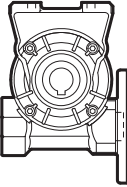
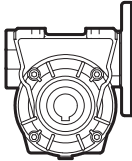
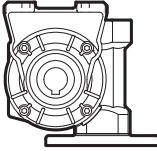
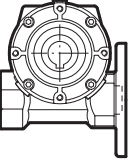
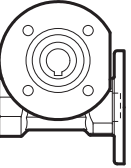
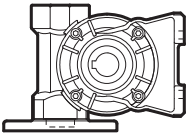
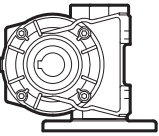
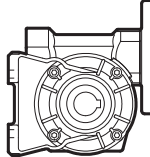
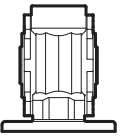
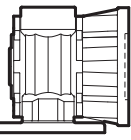
	MRDB..A	MRDB..N	MRDB..V	MRDB..P	MRDB..F
B3					
B6					
B7					
B8					
V5					
V6	